

1

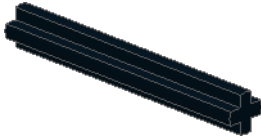

2

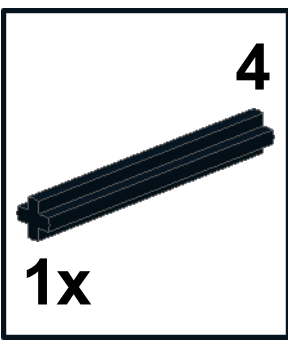
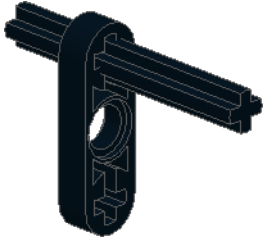
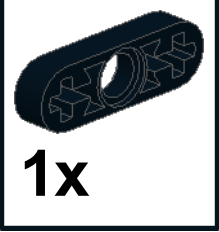

3

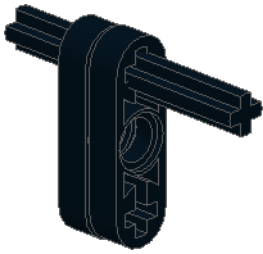
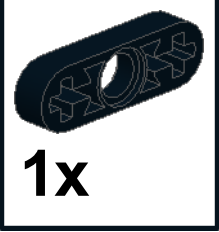

4

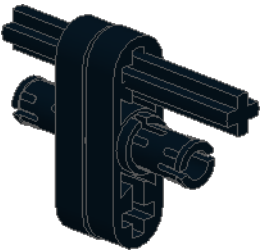
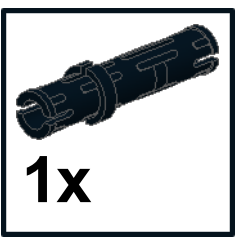

5

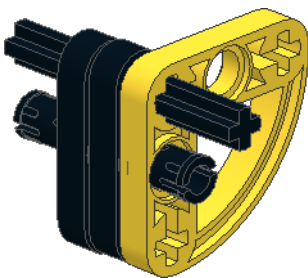
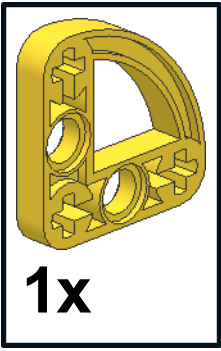

6

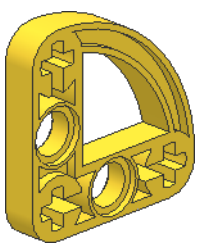

4

1x

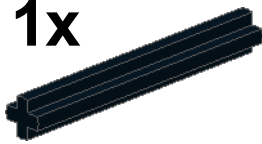

1x

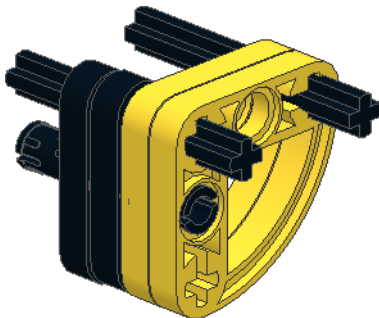

7

4

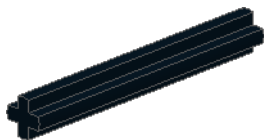

2x

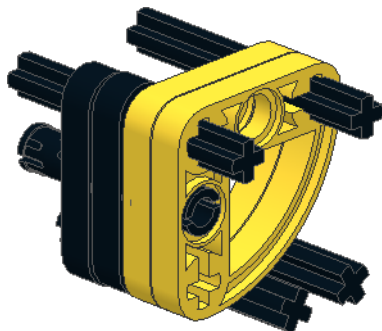

8

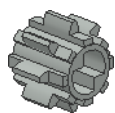

2x

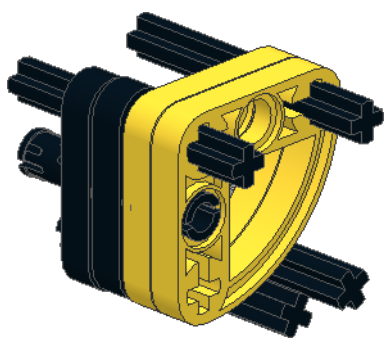

9



1x

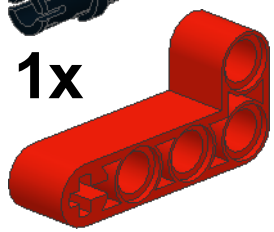

2x

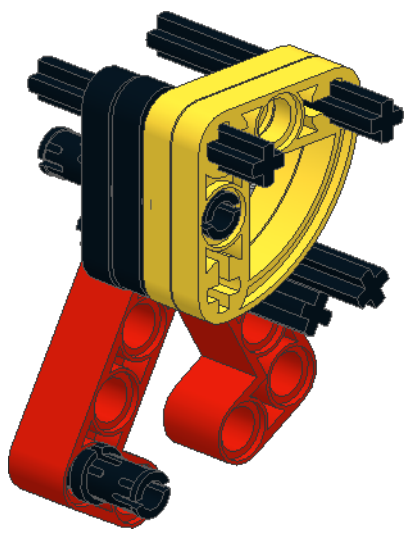

10

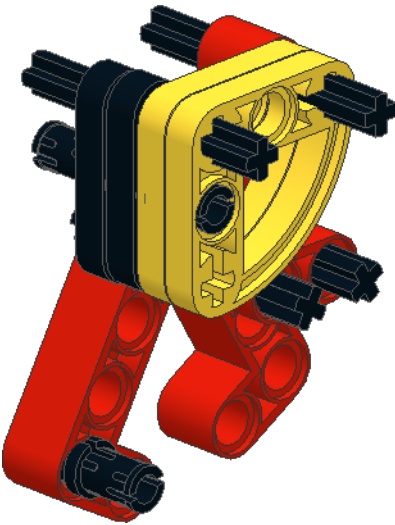
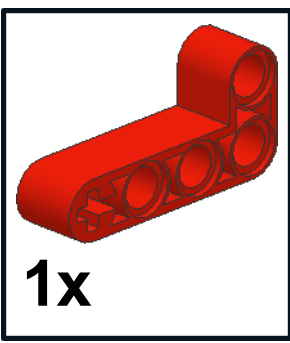

11

